

SERIES 136

DIGITAL INSIDE POINT CALIPER



ACCUD

- ◆ Measure the grooves
- ◆ Resolution: 0.01mm/0.0005"
- ◆ Automatic power on/off
- ◆ Buttons: mm/in, SET, preset(P+,P-)
- ◆ Preset: 2b, don't need to add the width of the jaws on the reading
- ◆ Data output
- ◆ Made of stainless steel

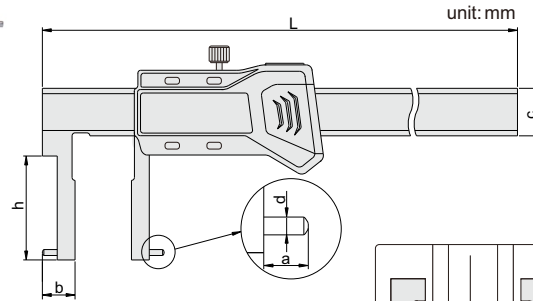
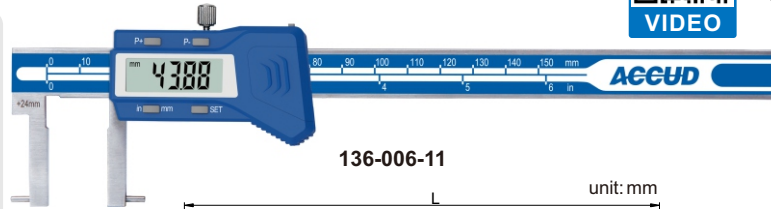

For range 500mm



Preset buttons



Code	Range	Accuracy	a	b	c	d	h	L
136-006-11	24-150mm	±0.04mm	5	12	16	Ø2	30	250
136-008-11	25-200mm	±0.04mm	5	12.5	16	Ø2	40	310
136-012-11	50-300mm	±0.07mm	8	25	17	Ø3	80	410
136-020-11	80-500mm	±0.07mm	16	40	24	Ø3	90	680
136-006-12	35-150mm	±0.05mm	6	17.5	16	Ø2	60	250
136-008-12	40-200mm	±0.05mm	7	20	16	Ø2	70	310
136-012-12	30-300mm	±0.05mm	5	15	16	Ø3	50	410
136-020-12	80-500mm	±0.08mm	16	40	24	Ø3	150	680

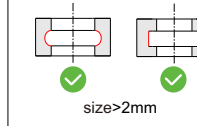
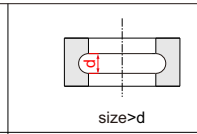
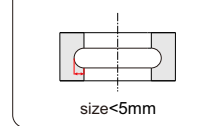
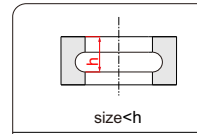
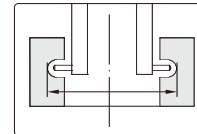

CALIPER